

TT 07 rail 230/400V (50Hz) (0.25 kW)

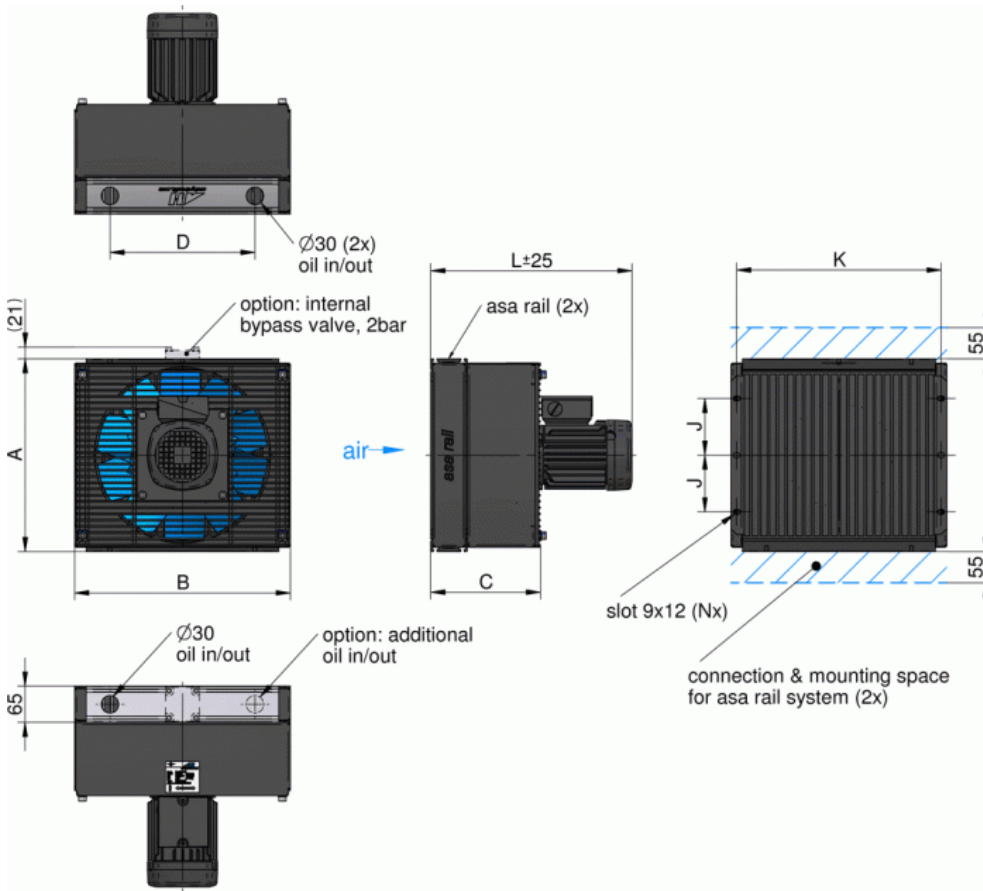

A:	300 mm	J:	86 mm
B:	320 mm	K:	290 mm
C:	193 mm	L:	396 mm
D:	178 mm	N:	4
G:	-	W:	-

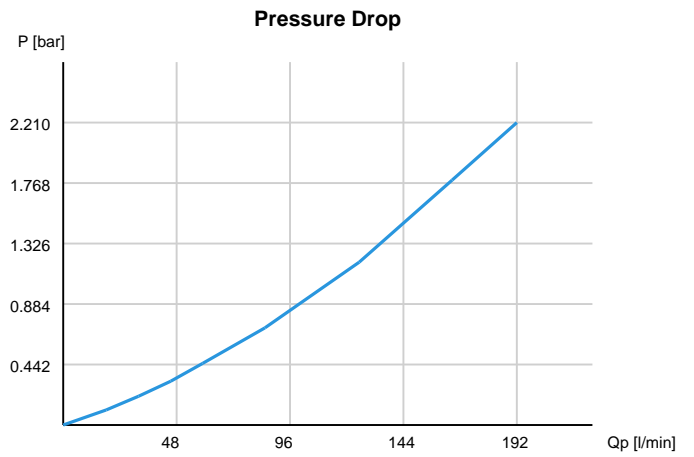
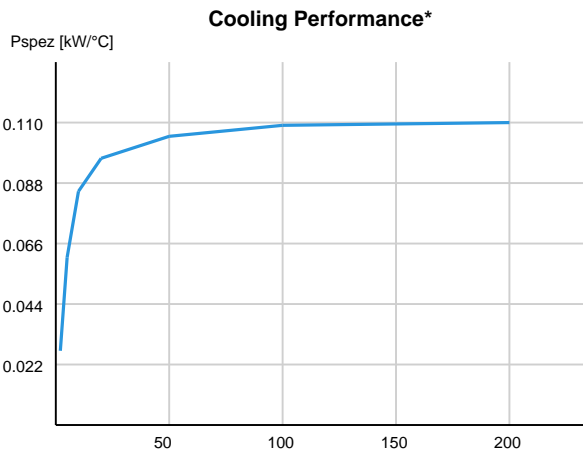

TT 07 rail 230/400V (50Hz) (0.25 kW)

Order Number	Motor Power	Current	Protection Level	Rotation	Air Flow	Noise Level	Weight
ASATT07RA44	0.25 kW	0.8 A	IP 55	1385 1/min	0.19 kg/s	65 db(A)	19.5 kg



Working pressure (static): 26 bar (370 PSI)
Radiator material: Aluminium

TT 07 rail 230/400V (50Hz) (0.55 kW)

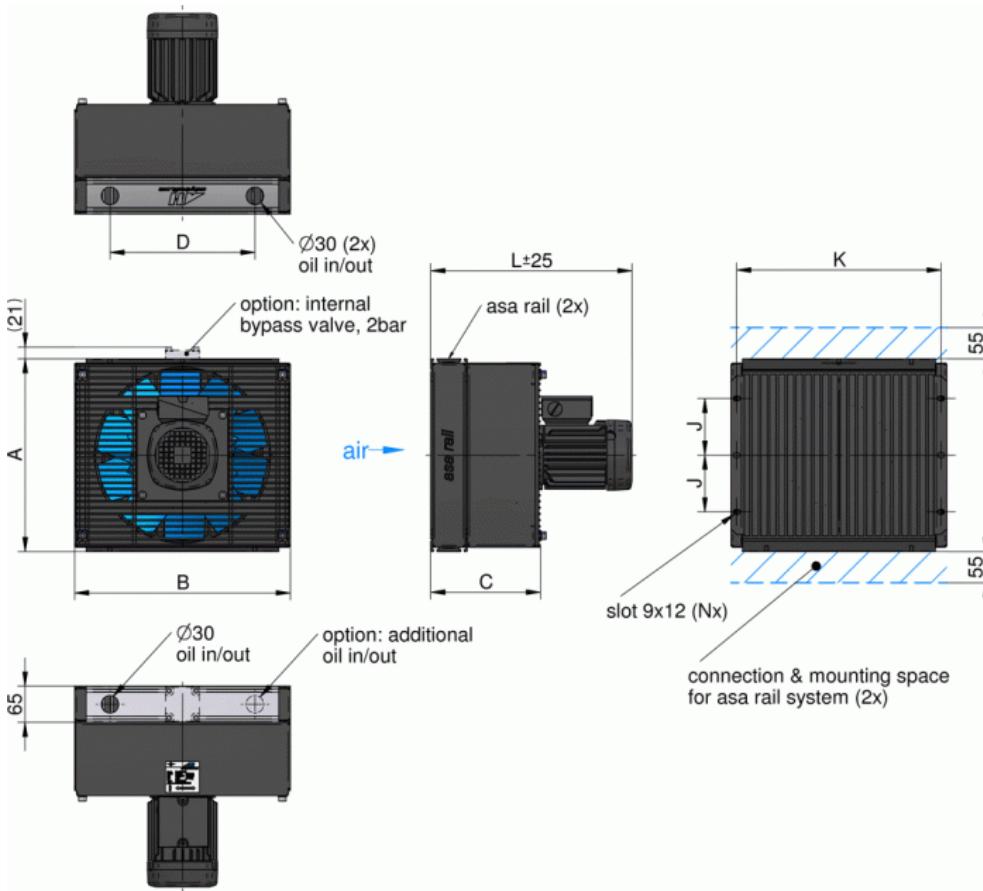

A:	300 mm	J:	86 mm
B:	320 mm	K:	290 mm
C:	193 mm	L:	396 mm
D:	178 mm	N:	4
G:	-	W:	-

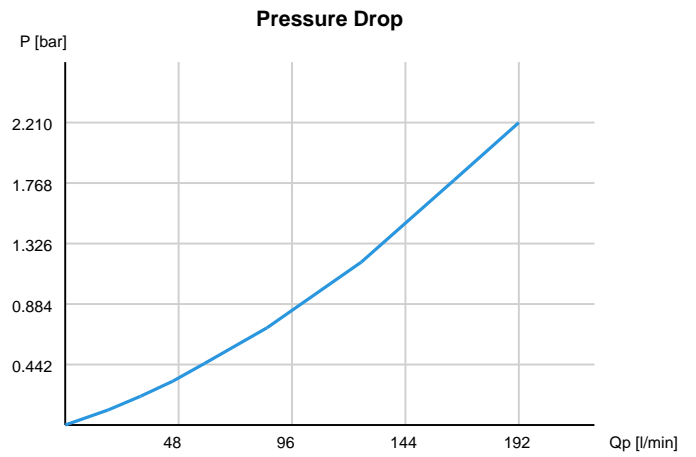
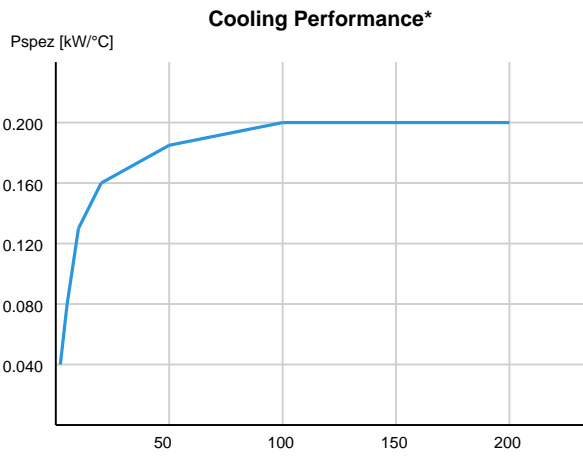

TT 07 rail 230/400V (50Hz) (0.55 kW)

Order Number	Motor Power	Current	Protection Level	Rotation	Air Flow	Noise Level	Weight
ASATT07RA25	0.55 kW	1.4 A	IP 55	2815 1/min	0.4 kg/s	81 db(A)	20.5 kg



Working pressure (static): 26 bar (370 PSI)
Radiator material: Aluminium

***Note - Cooling Performance**

The cooling performance mentioned in this homepage is conservative and measured at a test bench according to asa test procedures with oil type ISO VG 46 and presents a bases for your cooler selection regarding required cooling performance. Because there is no standard test procedure, tests used by other manufacturers might have different results. Due to different environment conditions the cooling performance can vary by +/- 15%.

Therefore we recommend all coolers be checked under the system operating conditions. This is also true for vibrations and mechanical stress as well as for pressure peaks and thermal stress.

General tolerance according to DIN 2768-v.

The information contained in this homepage is intended to be used as a guideline only. Customers should always confirm the suitability of the information and these products in their particular applications. ASA assumes no liability for any errors, commissions or misprints and reserves the right to change products and details without prior notification. As we are constantly improving our products, the characteristics, dimensions and weights can also change, although we do our best to incorporate these changes continually.

asa hydraulik GmbH
Prager Strasse 280
A-1210 Wien, Austria, Europe

Tel.: ++43 / 1 / 292 40 20
Fax: ++43 / 1 / 292 40 70

support@asahydraulik.com
www.asahydraulik.com