



**be different.  
make a difference.**

---

**Company Presentation**

# We are next to you.



## Key facts:

- manufacturer in USA, EU & Asia
- local account & application managers
- worldwide ERP management (SAP)

asa hydraulik GmbH  
R&D center Vienna



asa technology Produktions-  
und Vertriebs GmbH Vienna



asa hydraulik Technology  
(Suzhou) Co., Ltd. China



asa hydraulik of America, Inc.



asa hydraulik do Brasil



asa heat exchangers Pvt Ltd



asa Products Pty Ltd AUS.



# Be inspired.



## our engineering mindset:

1980 standardized

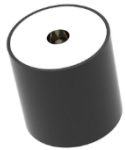

Quality through standardization!



2000 flexible



A step ahead flexibility!

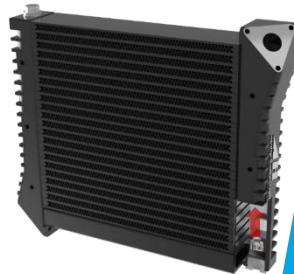
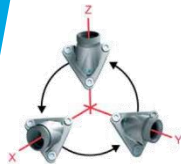

2017 unlimited

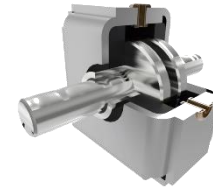

Changing limits!

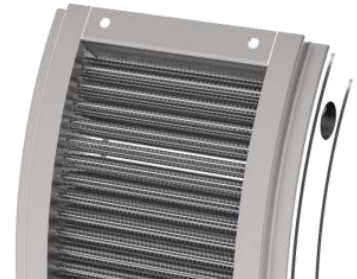

# How we perform.



history is written by the victors

## Experience since 1980.

- 1<sup>st</sup> 26bar cooler series
- **patented** low clogging block fin design
- ★ 1993: > 100.000/a produced units!

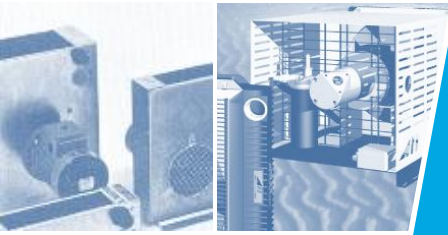

## Development in perfection.

- asa cooling integration system
- **patented** rail platform
- ★ 2005: > 500.000/a produced units!



## Innovation makes the difference.

- worldwide 1<sup>st</sup> electronic-cooling series
- **patented** air guide cooling technology
- ★ 2017: > 1.000.000/a produced units!

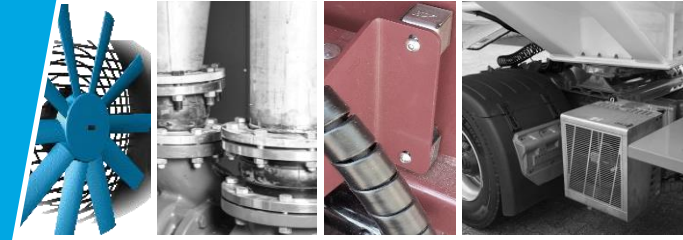

## product development structure

### Design and Simulation...

- finite elements analysis
- „KULI“ cooling network optimization
- „Simcenter“ computational fluid dynamics (CFD) thermal and flow simulations.

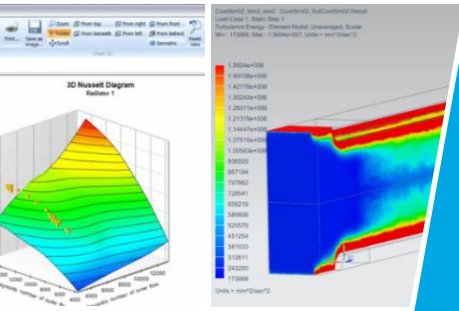

### Validation and Testing...

- performance acc. ISO 5801 / DIN EN1216,
- pressure related analysis 2014/68/EU
- material properties ISO 9227, DIN 60068/ISO16750...



### Production and Operation...

- global traceability & PPM monitoring
- local assembly and warehouses
- ISO 9001:2015
- ISO 14001:2015
- BS OHSAS 18001:2007

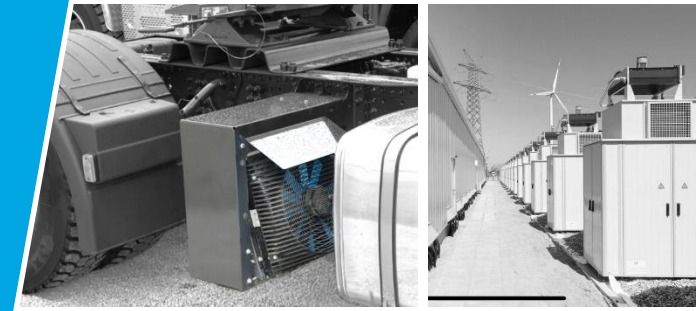

# How we support.



## business development processes

### Worldwide Logistics

- customized ERP connections,
- spare parts network,...



### Availability

- KANBAN system control,
- fast prototyping,
- global QM standards,...



### Support

- international communication
- faster than 3 days delivery program,
- technical training sessions,...



# What we supply.

## product portfolio

### Thermal Systems

- Plate & bar fluid/air
- Tube flex fluid/air
- Cold plate solid/fluid
- Shell tube fluid/fluid

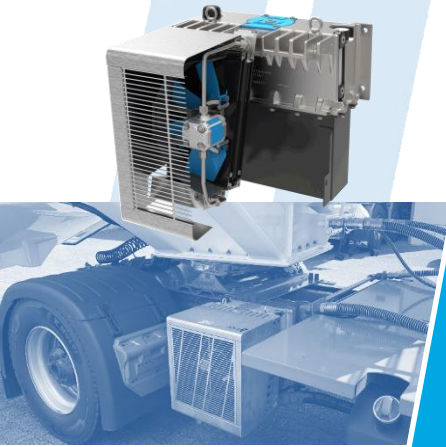

### Connection Technology

- Shut off valves
- Expansion joints
- Vibration absorbers



### Fluid Controls

- Oil Pumps
- Water Pumps

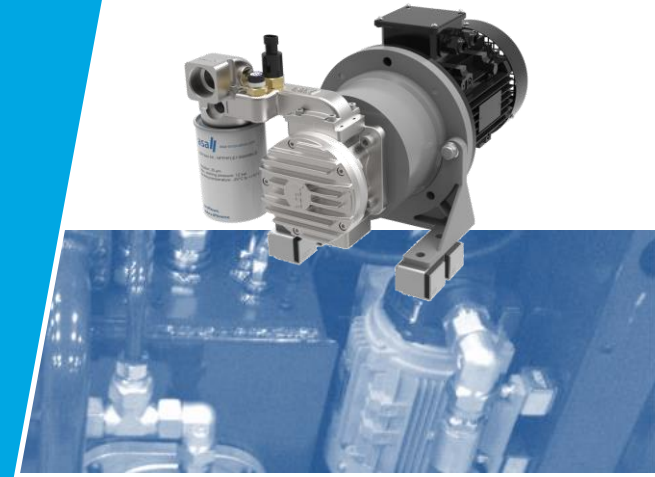

## heat exchanger designs

### Plate & Bar

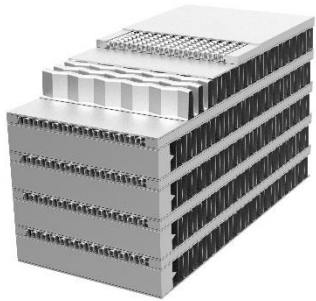

- fluid to air
- brazed & welded
- louvered, wavy or herringbone air fins

### Tube Flex



- fluid to air
- flexible air fin angle
- any shape of cooler

### Cold Plate



- solid to fluid
- electronic heat transfer
- light plate design

### Shell Tube Hybrid



- fluid to fluid
- variable materials
- fouling resistant



## solutions for challenging connection spots

### Vibration Control

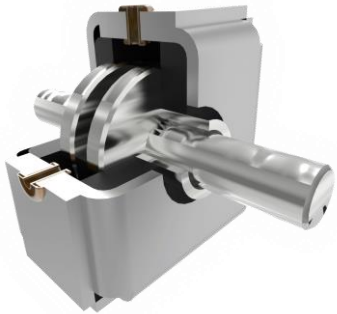

- rubber/metal damper
- durable shear load control
- steel wire systems

### Valves



- shut off solutions
- monitoring options
- aluminium, cast and stainless steel designs

### High & low pressure joints



- rubber expansion joints
- 16bar rating
- durable wire flange design

## fluid care, maintenance and control

### Gerotor 1 Pump



- gerotor technology
- low pulsation
- direct IEC flange

### Gerotor 2 motor/pump



- internal or external bypass
- flexible connections
- connection system to filters

### water centrifugal pumps



- brushless motor technology
- PWM control signal
- large e-cooling range

# We produce...



## ...with high environmental responsibility

- air-conditioned punch- and stacking halls
- automatic cleaning and drying machine

- vacuum brazing
- robot welding

- 100% pressurized digital leak test
- in house painting line

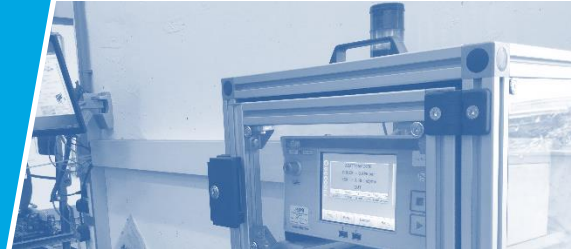

# We supply worldwide applications.



## Mobile



on- and off highway



agricultural and forestry machinery



construction and mining equipment



material handling



engine cooling

## Industrial



power transmission & gearboxes



lifting and municipal vehicles



compressors & air industry



forming and machining tools



oil & gas industry, marine equipment

## Green Energy



transformer and e-cooling



renewable and power generation



recycling and waste treatment

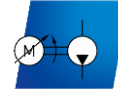

power units

# We work with...



## references overview



# Get in contact!

[www.asahydraulik.com](http://www.asahydraulik.com)  
[support@asahydraulik.com](mailto:support@asahydraulik.com)  
+43 1 292 40 20



## AUSTRIA

asa hydraulik GmbH  
R&D center  
Prager Strasse 280  
A-1210, Vienna

## USA

asa hydraulik of America  
160 Meister Avenue 20 A  
Branchburg, New Jersey 08876

## INDIA

asa hydraulik India Pvt Ltd  
C1/102/9, GIDC, Palej, Dt.Bharuch  
Gujarat - 392220

## AUSTRIA

asa technology Produktions- und  
Vertriebs GmbH  
Prager Strasse 280  
A-1210, Vienna

## CHINA

asa Technology (Suzhou) Co., Ltd.  
Jiangsu Suzhou Industrial Park  
Fangzhou Road No 128,  
area 6, building B

## AUSTRALIA

asa Products Pty Ltd  
Quinlan Road 23  
3076 Epping, Victoria

